

*VIDEO SENTRY Series*  
**PICTURE MEMORY UNIT**

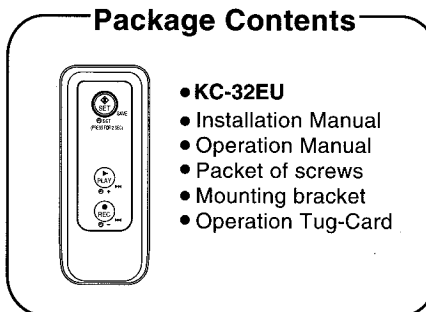

Model: **KC-32EU**, *Picture Memory Unit*

**INSTALLATION MANUAL**









 **Check the package contents before installation.**





**PRECAUTIONS ON INSTALLATION & WIRING**

-  **WARNING** *Negligence could result in death or serious injury.*
-  **CAUTION** *Negligence could result in injury or damage to property.*

 **WARNING**

1. Do not change or alter KC-32EU. It can cause fire or electric shock. 
2. Keep KC-32EU away from water or any other liquid. Fire or electric shock could result. 
3. Do not put any metal through openings of KC-32EU. It can cause fire, electric shock or unit damage. 
4. Keep AC cord of power supply from being marred or crushed. If damaged, fire or electric shock could result. 
5. Do not plug or unplug with wet hands. Electric shock could result. 
6. Keep AC plug away from moisture or dust. Fire could result. 
7. Do not use any power source other than specified. Fire or electric shock could result. 
8. Make sure wires are connected properly before plugging in power supply. 



 **CAUTION**



1. Do not install KC-32EU in any of the following locations, as it can cause fire, electric shock or unit damage: 
  - High or extreme cold temperature area, under direct sunlight, near equipment that varies in temperature, in front of air conditioner, inside a refrigerated area, etc.
  - Places subject to moisture or humidity extremes (bathroom, cellar, greenhouse, etc.) 
  - Places subject to environmental conditions, such as oil, dust, chemicals, salt, etc.
  - Places subject to constant vibration or impact.
  - Where noise generating devices such as TV or radio are close by.
  - Places subject to steam or smoke. (near heating equipment or cooking surfaces)



 **GENERAL PRECAUTIONS**

1. KC-32EU is designed for indoor use only. Do not install outdoors.
2. KC-32EU is not operational during a power failure.
3. In areas where broadcasting station antennas are close by, intercom system may be affected by radio frequency interference.
4. KC-32EU must be installed at least 1m, (3'3") away from TV or radio.

**Explanations of Symbols;**

 **GENERAL PRECAUTIONS:** —  mark indicates caution statement (incl. danger and warning), which is specifically shown inside.

 **GENERAL INSTRUCTIONS:** —  mark indicates contents which demands a specific action shown inside or attached.

 **GENERAL PROHIBITIONS:** —  mark indicates contents which prohibit a specific action shown inside or attached.

 **DISMANTLE PROHIBITIONS**

 **MOISTURE PROHIBITIONS**

# 1 MOUNTING

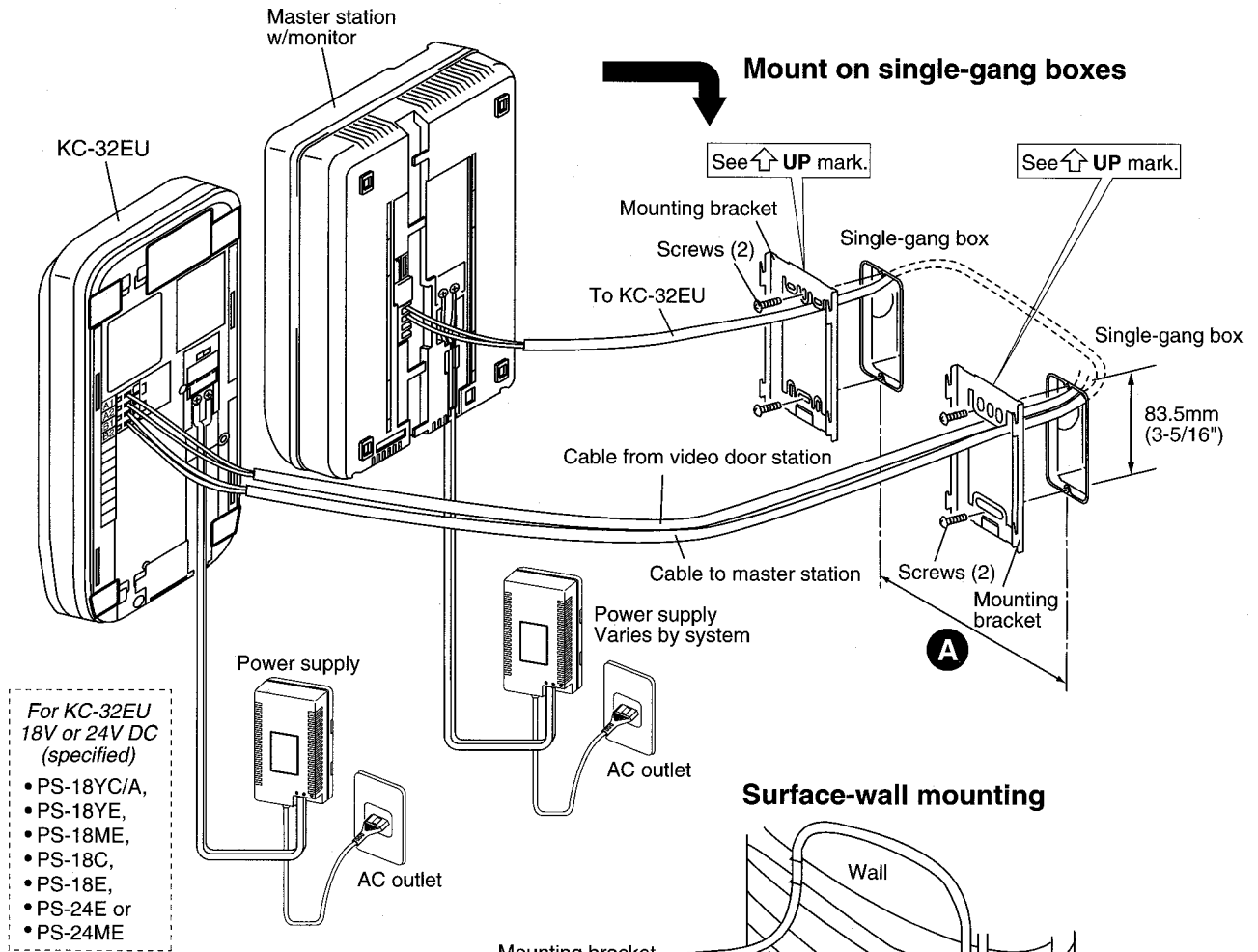

## Combination example

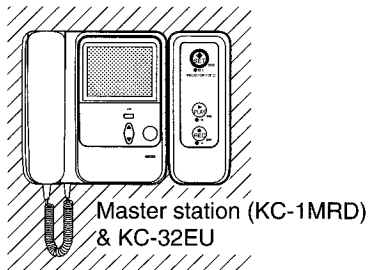

## Surface-wall mounting

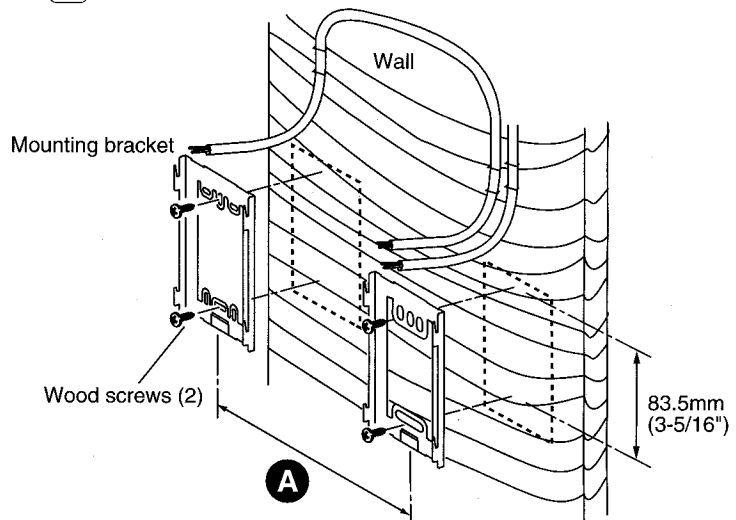

**Be sure to check the pitch (distance between boxes) in advance.**

### ■ Color monitor system

MODELS	BOX	<b>A</b> PITCH
KC-1MRD	1-gang	133mm (5-1/4")
KC-1GRD		
KB-3MRD		
KA-1MD		112mm (4-3/8")
KA-1MRD		

### ■ Black & white monitor system

MODELS	BOX	<b>A</b> PITCH
MK-1MD/A	1-gang	133mm (5-1/4")
MY-1CD		
MY-2CD		138mm (5-7/16")

**Refer to the Installation Manual packed with Monitor.**

## 2 WIRING

Be sure to set KC-32EU (date, time, mode). See Pages 4-5 of Operation Manual.

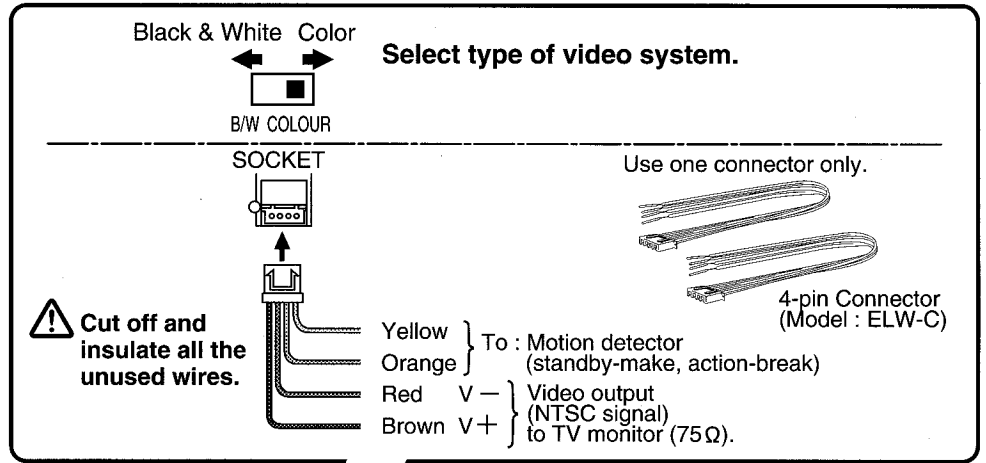

Video door station (KC-DAR)

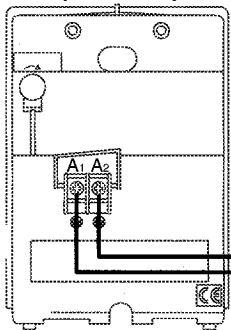

Picture memory unit KC-32EU

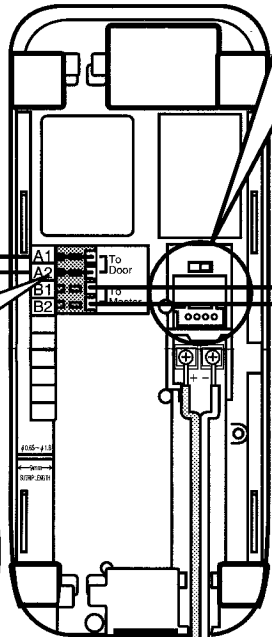

Master station (KC-1MRD)

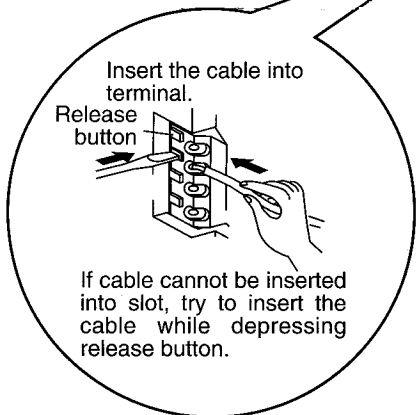
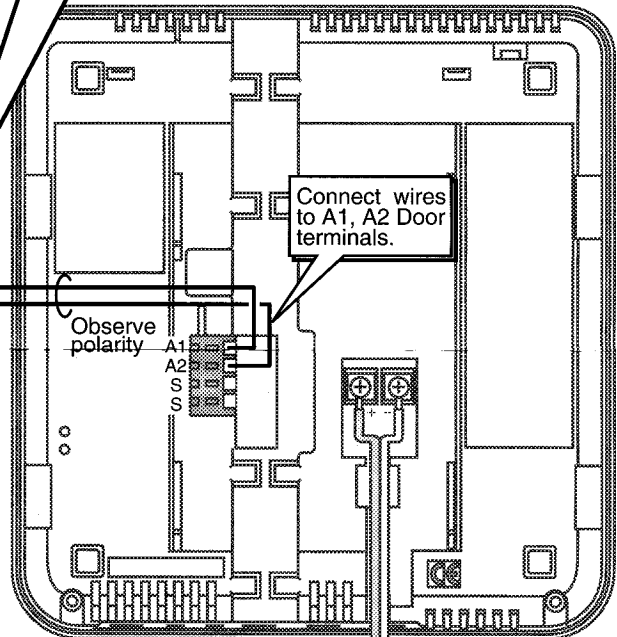

**⚠ Do not use any unused terminals for other purposes.**

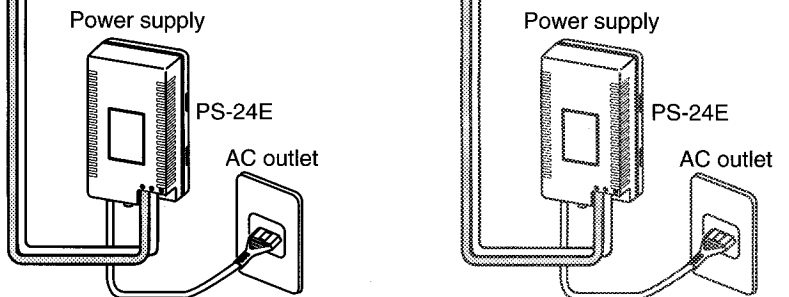

### Wiring Precautions

- Use a parallel conductor cable. Coaxial cable should not be used. For color video, viny jacketed, PE (polyethylene) insulation cable is recommended.
- Extra pair(s) in the installed cable can affect image quality, and must be terminated with a 120 ohm resistor at each end.

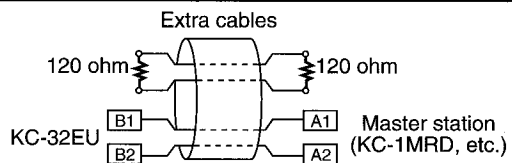

**⚠ KC-32EU and master station must be powered by a power supply directly.**

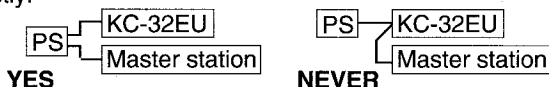

### 3 COMBINATION EXAMPLES

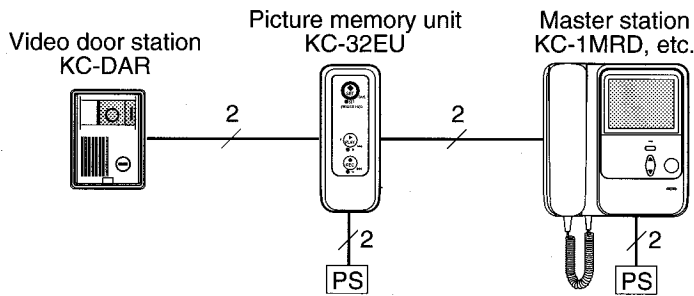

After installation & wiring, proceed with operational check according to the furnished Operation Manual.







#### Color video systems

Video door station	Master station
KC-DAR	KC-1MRD
	KC-1GRD
KB-DAR	KB-3MRD
KA-DA	KA-1MD
KA-DAR	KA-1MRD

#### Black & white video systems

Video door station	Master station
MK-DS/A	MK-1MD/A
MK-DAC, MK-DBC or MK-DGC	MY-1CD MY-2CD

### 4 TROUBLE SHOOTING GUIDE

TROUBLE MODE	POTENTIAL CAUSE OF TROUBLE	SOLUTION
<ul style="list-style-type: none"> <li>Picture is not saved when called.</li> <li>Cannot have saved pictures replayed with PLAY button .</li> <li>PLAY button  remains lit after replayed.</li> </ul>	<ul style="list-style-type: none"> <li>Wrong setting of color or black &amp; white selector.</li> <li>Check power status on KC-32EU.</li> </ul>	<ul style="list-style-type: none"> <li>Set the selector switch to proper position on back of KC-32EU.</li> </ul>
<ul style="list-style-type: none"> <li>SET button  does not light up.</li> <li>PLAY button  does not light up.</li> <li>REC button  does not light up.</li> </ul>	<ul style="list-style-type: none"> <li>Check power status on KC-32EU.</li> </ul>	<ul style="list-style-type: none"> <li>Turn on power of KC-32EU.</li> </ul>
<ul style="list-style-type: none"> <li>Both PLAY and REC buttons ,  are lit without reason.</li> </ul>	<ul style="list-style-type: none"> <li>Resetting date/time is necessary in case of power failure, etc.</li> </ul>	<ul style="list-style-type: none"> <li>Put KC-32EU in SET mode, and enter correct date and time.</li> </ul>

### 5 SPECIFICATIONS (KC-32EU)

• Power source:	18 V DC (Black & White).	24V DC (Color).
• Current consumption:	(Max.) 230mA.	(Max.) 160mA.
• Dimensions:	(Standby) 85mA.	(Standby) 65mA.
	80 (W)×195 (H)×54.5 (D) (mm).	
	3-1/8"(W)×1-1/16"(H)×2-1/8"(D).	
• Weight:	320g (0.71 lbs.) approx.	

This equipment has been tested and found to comply with the limits for a Class B digital device, pursuant to Part 15 of the FCC Rules. These limits are designed to provide reasonable protection against harmful interference in a residential installation. This equipment generates, uses, and can radiate radio frequency energy, and if not installed and used in accordance with the instructions, may cause harmful interference to radio communications. However, there is no guarantee that interference will not occur in a particular installation. If this equipment does cause harmful interference to radio or television reception, which can be determined by turning the equipment off and on, the user is encouraged to try to correct the interference by one or more of the following measures:

- Reorient or relocate the receiving antenna.
- Connect the equipment into an outlet on a circuit different from that to which the receiver is connected.
- Increase the separation between the equipment and receiver.
- Consult the dealer or an experienced radio/TV technician for help.

#### WARRANTY

Aiphone warrants its products to be free from defects of material and workmanship under normal use and service for a period of two years after delivery to the ultimate user and will repair free of charge or replace at no charge, should it become defective upon which examination shall disclose to be defective and under warranty. Aiphone reserves unto itself the sole right to make the final decision whether there is a defect in materials and/or workmanship; and whether or not the product is within the warranty.

This warranty shall not apply to any Aiphone product which has been subject to misuse, neglect, accident, or to use in violation of instructions furnished, nor extended to units which have been repaired or altered outside of the factory. This warranty does not cover batteries or damage caused by batteries used in connection with the unit.

This warranty covers bench repairs only, and any repairs must be made at the shop or place designated in writing by Aiphone. Aiphone will not be responsible for any costs incurred involving on site service calls.

AIPHONE CO., LTD., NAGOYA, JAPAN  
AIPHONE CORPORATION, BELLEVUE, WA, USA  
AIPHONE EUROPE N.V., ANTWERP, BELGIUM

KC-32EU-1/M (E) 1000C

COMMUNICATION SYSTEMS  
**AIPHONE**<sup>®</sup>  
HOME, BUSINESS, INDUSTRY.

Printed in Japan (E)