

*Chime Com 2*  
**CHIME INTERCOM**

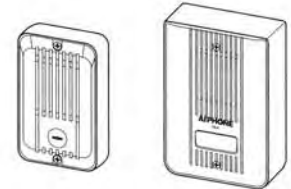



Model; **CCS-1A**      *Set of CC-1M & CC-DA*  
**CC-1M**                      *Room station*



**INSTALLATION & OPERATION MANUAL**

**Before actually installing CCS-1A, the contents of this Manual must be thoroughly read and understood.**







**PRECAUTIONS ON INSTALLATION & WIRING**

-  **WARNING**  
(Negligence could result in death or serious injury to people)
-  **GENERAL PRECAUTIONS**
-  General prohibitions.
-  Prohibitions to subject the unit to water.

-  **CAUTION**  
(Negligence could result in injury to people or damage to property)
-  Prohibitions to dismantle the unit.



**WARNING**

1. Do not change or modify CC-1M equipment. 
2. Do not connect any power source other than specified to WHITE wires on CC-1M. Doing so can cause fire or damage the unit. 
3. If an AC transformer rated more than 20V no-load voltage, is connected, it can damage the CC-1M units or cause fire. Aiphone is not responsible for any loss or damage incurred.
4. The CC-1M equipment must not be exposed to water or any other liquid. 
5. Do not open CC-1M equipment. Doing so can cause fire or damage the unit. 
6. Make sure wires are connected properly before plugging in the power supply. 
7. Keep AC outlet away from moisture and dust.

3. Do not install CC-1M equipment in any of the following locations, as it may cause the system to malfunction;
  - High or extreme cold temperature area: under direct sunlight, near equipment that varies in temperature, in front of air-conditioner, inside a refrigerated area, etc.
  - Places subject to moisture or humidity extremes.
  - Places subject to environmental conditions, such as oil, dust, chemicals, salt, etc. 
  - Places subject to constant vibration or impact.



**CAUTION**

1. Do not install or make any wire terminations while power supply is turned on. It can cause electrical shock or damage the unit.
2. Mount the CC-1M & CC-DA on wall in a convenient location, but not where it could be bumped or jarred.



**GENERAL PRECAUTIONS**

1. CC-1M equipment, except for CC-DA, is designed for indoor use only. Do not install outdoors.
2. CC-1M system is not operable during a power failure.
3. In areas where broadcasting station antennas are close by, intercom system may be affected by radio frequency interference.
4. Keep all DC wiring at least 30cm (1') away from AC 100 ~ 240V wiring, fluorescent lighting, or dimmer switches. Otherwise, cross AC wiring at a 90° angle.

# 1 SYSTEM OUTLINE & COMPONENTS

CCS-1A "Chime Com 2" is a set with a door station & an inside room station, powered by an AC transformer. Second room station CC-1M can be added with a separate AC transformer.

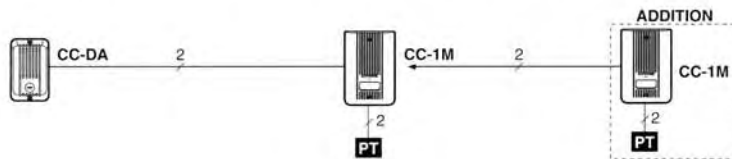

## ■ Package Contents

- |               |                                   |
|---------------|-----------------------------------|
| <b>CCS-1A</b> | • <b>CC-1M</b>                    |
|               | • <b>CC-DA</b>                    |
|               | • Packet of screws                |
|               | • Installation & Operation manual |
| <b>CC-1M</b>  | • <b>CC-1M</b>                    |
|               | • Packet of screws                |
|               | • Installation & Operation manual |

## ■ Components available

**CCS-1A:** Set of **CC-DA** door station & **CC-1M** inside room station.

**CC-1M:** Second room station.

**PT:** AC transformer. PT-1210N or 12-16V AC, 10VA (with no-load voltage ratings: 20V or less).

**⚠ DANGER WARNING:** - If an AC transformer rated more than 20V no-load voltage, is connected, it can damage the CC-1M units or cause fire. Aiphone is not responsible for any loss or damage incurred.

# 2 NAMES & FEATURES

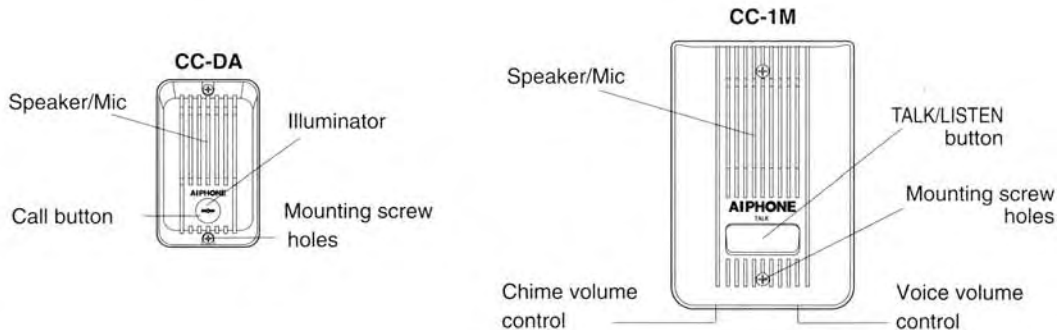

## ■ Features

- Press-to-talk door answering with auto shut off timer
- 2-tone electronic chime call-in
- Second inside room station. (Separate power supply required)
- Backlit CALL button
- CHIME and VOICE volume controls

### 3 INSTALLATION & WIRING

- **When replacing an existing doorbell:**  
Check to see how the existing doorbell is wired.

#### DIAGRAMS: Existing Doorbell, method 1

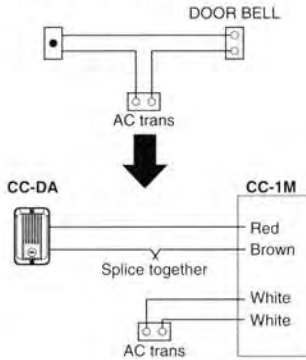

#### Method 1:

If there are only two matching colored wires located at the existing inside bell, the AC transformer was likely wired in series with the bell and button. If so, take the wires off of the AC transformer and splice them together, making a continuous wire to the bell. Measure the AC voltage with a volt meter. However, Aiphone is not responsible for any damage caused by power surge. Two additional wires must be run from the transformer to the location where the CC-1M room station will be installed. The two wires from the doorbell button must be connected to the RED/BROWN wires of the CC-1M, with NO AC voltage on the wires. Two wires from the AC transformer connect to the WHITE wires of the CC-1M room station. Remove the doorbell button outside and reconnect the two wires to the RED/BROWN wires on the CC-DA. Mount CC-DA to wall.

- **When replacing an existing doorbell:**  
Existing Doorbell, method 2 or New Installation:

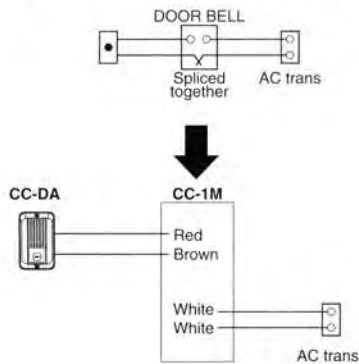

#### Method 2:

If there are two matching colored wires connected to the bell, and two(or more) additional matching colored wires spliced together but not connected to the bell, then there are likely enough wires to connect the Chime Com 2 without running new wire.

1. Take wires off of bell, and separate the wires that are spliced together.
2. Locate the bell transformer currently installed, disconnect it from the existing bell, and measure the AC voltage with a volt meter. However Aiphone is not responsible for any damage caused by power surge. Connect the pair from the AC transformer to the WHITE wires on the CC-1M. Connect the other pair of wires (which go to the door) to the RED/BROWN wires on the CC-1M.
3. Outside, remove the doorbell button, and connect the two wires to the CC-DA door station, then mount on the wall.

**NOTE:** When the inside room station is to be installed in a different location, splice wires from the existing doorbell location and run new wire to the desired location for the new room station. Either leave the existing doorbell on the wall but disconnected, or remove it and patch the wall as needed.

- **How to measure AC no-load voltage**

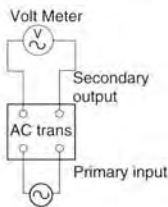

Turn off circuit breaker powering AC transformer, and disconnect secondary output wires. Turn circuit breaker back on, and measure secondary output terminals with a volt meter. If the reading is between 12-20V, it can be used to power the CC-1M.

If you cannot safely perform this function, or if the transformer does not meet the specification, install a standard AC outlet and use the Aiphone PT-1210N plug-in transformer.

- **Power supply**

The power source for the CC-1M must meet the following specifications:

- AC no-load voltage: Min. 12V, Max. 20V.
- UL LISTED and Class 2 rated or marked.
- Ratings: 12-16V AC, 10VA or more.

- **Second room station**

Another CC-1M station can be added to the system. It requires a separate power supply, and is to be wired (polarized) from the first inside station (not the door).

## ■ WIRING DIAGRAM

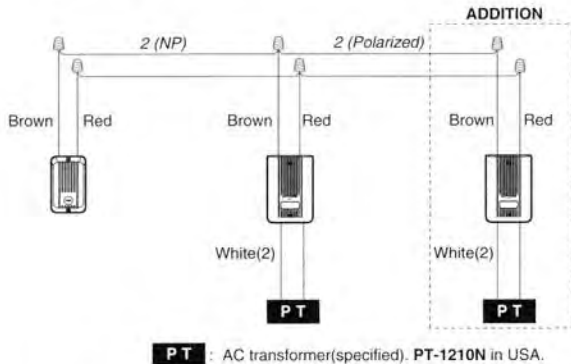

## 4 MOUNTING

CC-DA mounts on surface of wall with 2 screws.

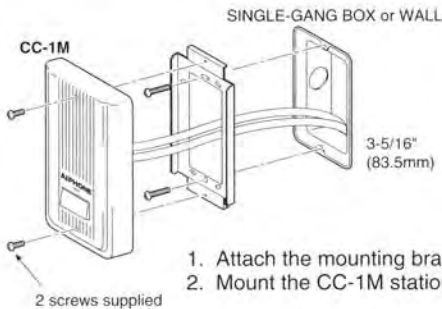

## 5 OPERATIONS

At CC-DA door, press CALL button (backlit) once. A muted chime will be heard at the door. At CC-1M room station(s), 2-tone chime sounds. Press TALK button to transmit, and release to listen. The system automatically turns off in 15 seconds after last time the TALK button is pressed. Press TALK button to recycle.

### • Chime & voice volume adjustments:

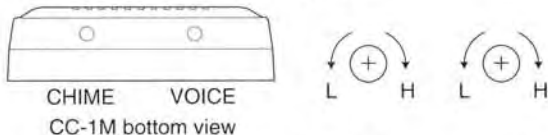

## WARRANTY

Aiphone warrants its products to be free from defects of material and workmanship under normal use and service for a period of one year after delivery to the ultimate user and will repair free of charge or replace at no charge, should it become defective upon which examination shall disclose to be defective and under warranty. Aiphone reserves unto itself the sole right to make the final decision whether there is a defect in materials and/or workmanship; and whether or not the product is within the warranty.

This warranty shall not apply to any Aiphone product which has been subject to misuse, neglect, accident, or to use in violation of instructions furnished, nor extended to units which have been repaired or altered outside of the factory. This warranty does not cover batteries or damage caused by batteries used in connection with the product.

This warranty covers bench repairs only, and any repairs must be made at the shop or place designated in writing by Aiphone.

Aiphone will not be responsible for any costs incurred involving on site service calls.

Aiphone Co., Ltd., Nagoya, Japan  
Aiphone Corporation, Bellevue, WA, USA

CCS-1A-I(E) 0697B

#90115

## 6 TECHNICAL PRECAUTIONS

- CCS-1A components are not compatible with C-123L/A units.
- In 2-CC-1M system;
  1. There is no calling between CC-1M stations.
  2. If both CC-1M's press the TALK button (meaning both masters are on), a squeal will be heard when either CC-1M presses the TALK button. Wait until system turns itself off before using.
- **To prevent acoustic feedback;**  
Do not mount a door station & a room station back to back on a common wall. With conduit wiring, pack conduit with foam or insulation for best results.
- CC-DA is weather resistant. If possible and for best results, install the door station in an area not directly exposed to weather.
- Do not apply caulking or sealant around door station, so the openings allow moisture to dissipate.
- Do not put direct pressure water on CC-DA door station.
- Clean CC-1M unit with a soft cloth dampened with neutral household cleanser. Never use any abrasive cleaner or cloth.

## 7 SPECIFICATIONS (CC-1M)

- **Power source:** 12-16V AC, 10VA.
- **Power supply:** AC transformer PT-1210N in USA (specified) or 12-16V 10VA AC (with no-load voltage rating: 20V or less).
- **Communication:** 2-tone chime call-in.  
Press "TALK" button on room station to talk, release to listen. Hands free at door. 15 sec. time out after last time TALK button released.
- **Controls:** CHIME vol. VOICE vol.
- **Wiring:** 2 parallel wires, non-polarized to door.  
2 wires to another room, polarized.  
2 wires to PT-1210N (from ea. CC-1M)
- **Distance:**

	22AWG(0.65mmø)	18AWG(1.0mmø)
CC-DA to CC-1M (or 2nd)	245'(75m)	590'(180m)
CC-1M to AC transformer	65'(20m)	145'(45m)

### • Dimensions & weight:

CC-1M: 7"H x 4-3/4"W x 1-5/16"D. 180H x 123W x 33D (mm). 400g (0.88lbs.).
CC-DA: 4-1/2"H x 2-3/4"W x 1-3/16"D. 114H x 70W x 30D (mm). 150g (0.33lbs.).